

# 冲压外圈滚针轴承

## Drawn Cup Needle Roller Bearings

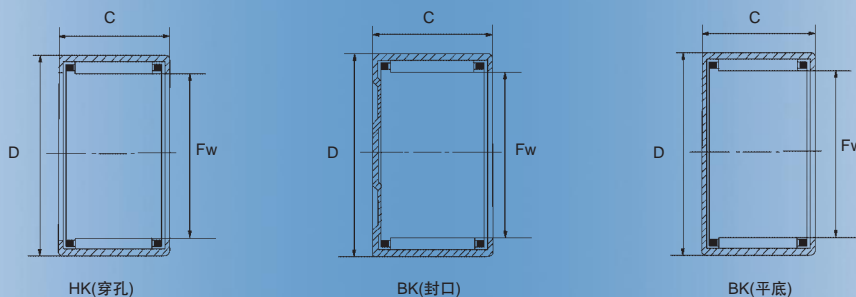

轴径 Shaft Diameter	轴承型号 Bearing Designation		重量 Mass 近似 Approx	外形尺寸 Boundary Dimensions			额定负荷 Basic Load Rating		极限转速 Limiting Speed
	现型号 Current Code	原型号 Original Code		Fw	D	C	动 Dynamic	静 Static	
mm			g	mm			N		rpm
3	HK0306TN			3	6.5	6	1320	950	6000
	BK0306TN			3	6.5	6	1320	950	6000
4	HK0408TN	37941/4	1.6	4	8	8	1540	1070	40000
	BK0408TN	5941/4	1.8	4	8	8	1540	1070	40000
5	HK0509TN			5	11	9	2200	1790	36000
	HK0509	47941/5	2	5	9	9	2200	1790	36000
	BK0509	45941/5	2.1	5	9	9	2200	1790	36000
	HK0510			5	9	10			
6	HK0606			6	10	6			
	HK0607	27941/6	1.8	6	10	7	1600	1400	30000
	HK0608	37941/6	2.1	6	10	8	1830	1550	32000
	BK0608	35941/6	2.2	6	10	8	1830	1550	32000
	HK0609	47941/6	2.2	6	10	9	2650	2400	30000
	BK0609	45941/6	2.6	6	10	9	2650	2400	30000
	HK0611		2.3	6	10	11	1700	1500	29000
7	HK06X12X8	3941/6	2.5	6	12	8	2230	2010	33000
	HK0708			7	11	8	2800	2150	27000
	HK0709	47941/9	2.3	7	11	9	2800	2150	27000
	BK0709	45941/9	2.9	7	11	9	2800	2150	27000
	HK0712			7	11	12			
	HK07X12X08		2.2	7	12	8	3300	3220	37000
8	HK07X12X09		2.4	7	12	9	3400	3150	37000
	HK0808	37941/8	2.7	8	12	8	2550	2400	21000
	HK0808TN			8	12	8			
	BK0808	35941/8	3	8	12	8	2550	2400	21000
	HK0810	57941/8	3	8	12	10	3700	3450	21000
	BK0810	88941/8	3.4	8	12	10	3700	3450	21000
	HK0812	67941/8		8	12	12			
	HK08X14X10	27942/8	5.35	8	14	10	3800	3950	25000
9	BK08X14X10	25942/8	5.8	8	14	10	3800	3950	25000
	HK08X14X12	37942/8	6.6	8	14	12	4100	4320	25000
	HK0908	37941/9	3	9	13	8	3650	4050	25000
	BK0908	35941/9	3.4	9	13	8	3650	4050	25000
	HK0910	57941/9	4	9	13	10	4050	4250	25000
	BK0910	55941/9	4.3	9	13	10	4050	4250	25000
	HK0911		4.1	9	13	11	4300	4700	25000
	HK0912	67941/9	4.6	9	13	12	5000	6000	25000
	BK0912	65941/9	4.9	9	13	12	5000	6000	25000
	HK09X15X10	27942/9	5.6	9	15	10	5300	6300	25000

# 冲压外圈滚针轴承

## Drawn Cup Needle Roller Bearings

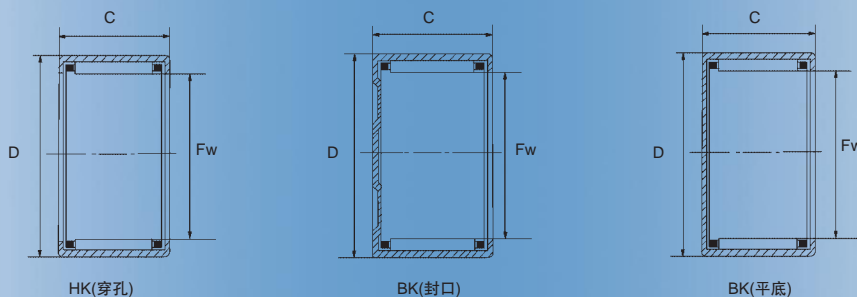

轴径 Shaft Diameter	轴承型号 Bearing Designation		重量 Mass 近似 Approx	外形尺寸 Boundary Dimensions			额定负荷 Basic Load Rating		极限转速 Limiting Speed
	现型号 Current Code	原型号 Original Code		Fw	D	C	动 Dynamic	静 Static	油润滑 Oil
mm			g	mm			N		rpm
10	HK10X13X08		3.5	10	13	8	4100	4800	20000
	HK1010	57941/10	4.1	10	14	10	3900	4800	19000
	BK1010	55941/10	4.3	10	14	10	3900	4800	19000
	HK1012	67941/10	4.8	10	14	12	5000	6300	19000
	BK1012	65941/10	5	10	14	12	5000	6300	19000
	HK1015		6	10	14	15	6700	7800	19000
	BK1015		6.2	10	14	15	6700	7800	19000
	HK10X15X15	644900	6.5	10	15	15	6800	8800	18000
	HK10X16X10		6.5	10	16	10	6800	8800	18000
	BK10X16X10		6.8	10	16	10	6800	8800	18000
	HK10X16X12	DB1012	7.5	10	16	12	6800	8800	18000
	HK10X16X15	7942/10	11	10	16	15	6800	8800	19000
	HK10X17X15		11.5	10	17	15	7200	8000	19000
HK10X18X12		8.5	10	18	12	7200	8000	19000	
12	HK1208	37941/12	3.3	12	16	8	7200	8000	19000
	HK1210	57941/12	4.6	12	16	10	4150	5800	19000
	BK1210	55941/12	5.2	12	16	10	4150	5800	19000
	HK1212	67941/12	5.6	12	18	12	3800	5100	15000
	BK1212	65941/12	6.2	12	16	12	3800	5100	15000
	HK12X17X12	7941/12	7.5	12	17	12	5100	7000	15000
	HK12X17X15	7942/12	9.5	12	17	15	5100	7000	15000
	HK12X17X18	7943/12	11	12	17	18	5100	7000	15000
	HK12X18X12	37942/12	9.1	12	18	12	5500	6300	17000
	BK12X18X12	35942/12K	10.3	12	18	12	5500	6300	17000
	HK12X18X14	67942/12	10.6	12	18	14	6500	6300	15000
HK12X19X12		10	12	19	12	6800	7400	15000	
13	HK1311		8.5	13	19	11	6300	6300	14000
	HK1312		8.9	13	19	12	6200	7100	17000
	BK1312		11.2	13	19	12	6200	7100	17000
13.5	HK13.5X19X12			13.5	19	12	6200	7100	16000
	HK13.5X20X12	7941/13.5	10.8	13.5	20	12	6250	7590	16000
14	HK1410	27941/14	8.3	14	20	10	6700	7000	16000
	BK1410	35941/14	12.1	14	20	10	6700	7000	16000
	HK1412	37941/14	10.5	14	20	12	6800	7500	16000
	HK1416	57941/14	13.9	14	20	16	7300	9000	14000
	HK1418			14	20	18	7300	9000	14000
15	HK15X20X12	7941/15	8.4	15	20	12	5800	6000	14000
	HK15X20X16	7942/15	11.4	15	20	16	6000	6200	14000
	HK15X20X20	7943/15	13.8	15	20	20	6100	6400	14000

# 冲压外圈滚针轴承

## Drawn Cup Needle Roller Bearings

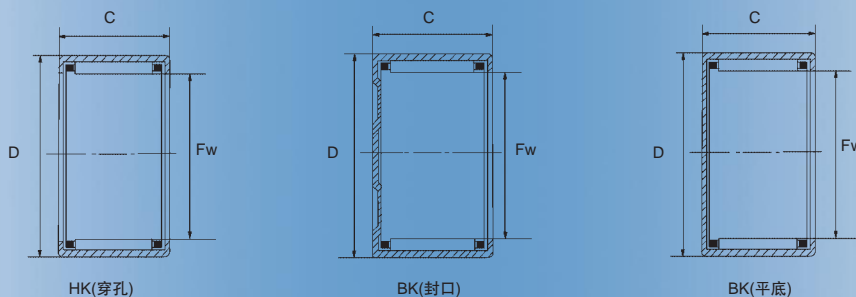

轴径 Shaft Diameter	轴承型号 Bearing Designation		重量 Mass 近似 Approx	外形尺寸 Boundary Dimensions			额定负荷 Basic Load Rating		极限转速 Limiting Speed	
	现型号 Current Code	原型号 Original Code		Fw	D	C	动 Dynamic	静 Static		
mm			g	mm			N		rpm	
15	HK1512	37941/15	11.1	15	21	12	7000	8400	14000	
	BK1512	35941/15	12.7	15	21	12	7000	8400	14000	
	HK1514	47941/15	12.7	15	21	14	8500	10400	13000	
	HK1515		14.2	15	21	15	9100	11400	13000	
	BK1515			15	21	15	9800	11400	14000	
	TA1515			15	22	15		11400		
	TA1515Z			15	22	15		11400		
	HMK1515			15	22	15				
	HK1516	57941/15	15	15	21	16	9800	11400	14000	
	BK1516	55941/15	16.5	15	21	16	9800	11400	14000	
	HK1518				15	21	18			
	HK1520				15	21	20			
	HMK1520				15	22	20			
	HK1522	SZ-439	20.4	15	21	22	10400	16500	14000	
	BK1522		22	15	21	22	10400	16500	14000	
	HK15X22X12	7948/15	12.5	15	22	12	14300	18400	13000	
HK15X22X12.5	7948/15K	13.5	15	22	12.5	14300	18400	13000		
16	HK16X21X06		5.5	16	21	6	4200	5300	12000	
	HK16X21X09		7.5	16	21	9	4400	5600	12000	
	HK1610	27941/16		16	22	10				
	HK1612	37941/16	11.7	16	22	12	7100	9200	14000	
	BK1612	35941/16	13.8	16	22	12	7100	9200	14000	
	HK1612K			16	22	12				
	HK1614	47941/16	14.4	16	22	14	8800	9900	12000	
	HK1616	57941/16	15.8	16	22	16	10100	14300	14000	
	BK1616	55941/16	17.6	16	22	16	10100	14300	14000	
	HK1616-ASI			16	22	16				
	HK1617	SZ-435	18	16	22	17	12900	17200	12000	
	HK1620	77941/20		16	22	20				
HK1622	87941/16	21.7	16	22	22	11100	17400	14000		
BK1622	85941/16	23.4	16	22	22	11100	17400	14000		
17	HK17X21.5X15	17BTM15	10	17	21.5	15	6300	8600	11000	
	HK1712	37941/17	12.2	17	23	12	6900	9300	13000	
	BK1712	35941/17	14.5	17	23	12	6900	9300	13000	
	HK1714	7941/17	14	17	23	14	6800	10200	10000	
	HK1716	57941/17	15.9	17	23	16	8500	12500	10000	
	BK1716			17	23	16	8500	12500	10000	
	HK1718	7942/17	19	17	23	18	9500	10600	10000	
	HK1720			17	23	20	10000	11800	10000	

# 冲压外圈滚针轴承

## Drawn Cup Needle Roller Bearings

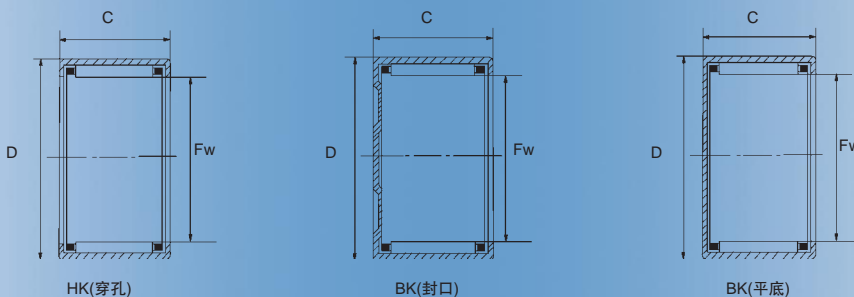

轴径 Shaft Diameter	轴承型号 Bearing Designation		重量 Mass 近似 Approx	外形尺寸 Boundary Dimensions			额定负荷 Basic Load Rating		极限转速 Limiting Speed	
	现型号 Current Code	原型号 Original Code		Fw	D	C	动 Dynamic	静 Static	油润滑 Oil	
mm			g	mm			N		rpm	
17	HK1722	7943/17	17	17	23	22				
	HK17X24X15		17	17	24	15	11200	12800	10000	
	HK17X25X14	37942/17K	17.7	17	25	14	13100	14700	10000	
	HK17X25X15.5		20	17	25	15.5	9320	10400	10000	
	HK17X25X18	57942/17K	23.5	17	25	18	9500	10600	11000	
18	HK1812	37941/18	13.1	18	24	12	7100	9900	12000	
	BK1812	35941/18	14.9	18	24	12	7100	9900	12000	
	HK1816	57941/18	17.5	18	24	16	10600	15300	12000	
	BK1816	55941/18	19.9	18	24	16	10600	15300	12000	
	HK18X24X20		18	18	24	20				
	HMK1825			18	25	25				
19	HK19X27X16	TA1916	23	19	27	16	8100	9500	10500	
20	HK2010	27941/20	11.8	20	26	10	5900	7200	10000	
	BK2010	25941/20	14	20	26	10	5900	7200	10000	
	HK2011		12	20	26	11	7500	9200	9000	
	HK2012	37941/20	14.1	20	26	12	7600	10100	10000	
	BK2012	35941/20	16.7	20	26	12	7600	10100	10000	
	HK2014	47941/20	15.7	20	26	14	9700	18100	9000	
	HK2016	57941/20	19.3	20	26	16	11700	29100	10000	
	BK2016	55941/20	22.3	20	26	16	11700	29100	10000	
	HK2018	67941/20	23.3	20	26	18	7900	12800	9000	
	HK2020	7942/20	24.1	20	26	20	13700	24000	10000	
	BK2020	75941/20	27.1	20	26	20	13700	24000	10000	
	HK2025	7943/20	28	20	26	25	9100	14800	9900	
	HK2030		41	20	26	30	21800	40000	10100	
	BK2030		43	20	26	30	21800	40000	10100	
	HK20X27X18				20	27	18	26000	47200	9900
	HK20X27X20					20	27	20	26300	47800
HK20X27X30					20	27	30	28500	48800	9900
HK20X28X16	47942/20	28.5	20	28	16	29600	49800	9900		
HK20X29X18		41	20	29	18	30900	54600	9900		
22	HK22X28X7.5TN		8.8	22	28	7.5	5200	7000	10100	
	HK2210	27941/22	12.3	22	28	10	7200	9500	10100	
	HK2212	37941/22	15	22	28	12	8100	10400	10100	
	BK2212	35941/22	18.1	22	28	12	8100	10400	10100	
	HK2216	57941/22	20.9	22	28	16	11400	18100	10100	
	BK2216	55941/22	24.3	22	28	16	11400	18100	10100	
	HK2220	77941/22	26.2	22	28	20	14500	25000	10100	
	BK2220	75941/22	29.9	22	28	20	14500	25000	10100	

# 冲压外圈滚针轴承

## Drawn Cup Needle Roller Bearings

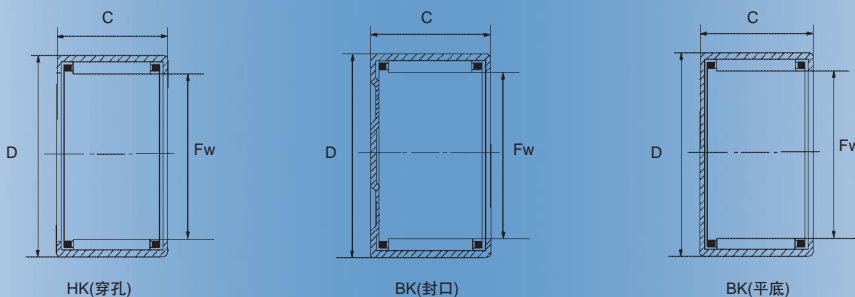

轴径 Shaft Diameter	轴承型号 Bearing Designation		重量 Mass 近似 Approx	外形尺寸 Boundary Dimensions			额定负荷 Basic Load Rating		极限转速 Limiting Speed
	现型号 Current Code	原型号 Original Code		Fw	D	C	动 Dynamic	静 Static	油润滑 Oil
mm			g	mm			N		rpm
22	HMK2225			22	29	25			
	HK2230		32	22	28	30	17500	30400	9000
	HK22X29X25		37	22	29	25	18100	31500	9000
	HK22X25X30		43	22	29	30	19400	33100	9000
	HK22X30X14	37942/22	21.9	22	30	14	19800	34000	9000
24	HK24X30X7.5TN		10.6	24	30	7.5	5800	7200	10000
25	HK2512	27941/25	20	25	32	12	10000	14200	9000
	BK2512	25941/25	23.2	25	32	12	10000	14200	9000
	HK2514	37941/25	21.9	25	32	14	13600	18700	9000
	HK2516	7941/25	27.3	25	32	16	13600	20000	9000
	BK2516	5941/25	31	25	32	16	13600	50000	9000
	HK2518	57941/25	28.2	25	32	18	17500	25800	9000
	HK2520	67941/25	34.1	25	32	20	17900	30000	9000
	BK2520	65941/25	38.7	25	32	20	17900	30000	9000
	HK2525	7943/25	40	25	32	25	22200	36700	9000
	HK2526		44.8	25	32	26	22500	42000	9000
	BK2526		49	25	32	26	22500	42000	9000
	HK2538	87941/25	64.7	25	32	38	30000	58000	9000
	BK2538	85941/25	69	25	32	38	30000	58000	9000
	HK25X33X10		17	25	33	10	34800	69600	9000
	HK25X33X15		27.4	25	33	15	35700	70000	9000
HK25X35X20	57942/25	44.9	25	35	20	36100	78650	9000	
28	HK2812			28	35	12			
	HK2816	47941/28	30.1	28	35	16	15400	22500	8700
	BK2816	45941/28	34.1	28	35	16	15400	22500	8700
	HK2818	57941/28	31.7	28	35	18	18500	29300	8700
	HK2820	67941/28	37.6	28	35	20	18900	32000	8700
	BK2820	65941/28	43	28	35	20	18900	32000	8700
	HK2825			28	35	25			
	HK2830			28	35	30			
30	HK3012	27941/30	24	30	37	12	10100	16200	8100
	BK3012	25941/30	27.9	30	37	12	10100	16200	8100
	HK3016	47941/30	32	30	37	16	15200	27000	8100
	BK3016	45941/30	37.1	30	37	16	15200	27000	8100
	HK3018	57941/30	33.6	30	37	18	19200	31500	8100
	HK3020	67941/30	40.1	30	37	20	19700	33500	8100
	BK3020	65941/30	46.5	30	37	20	19700	33500	8100
	HK3020-K			30	37	20			

# 冲压外圈滚针轴承

## Drawn Cup Needle Roller Bearings

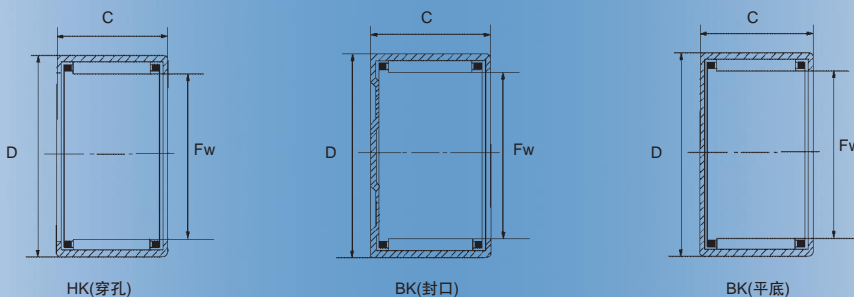

轴径 Shaft Diameter	轴承型号 Bearing Designation		重量 Mass 近似 Approx	外形尺寸 Boundary Dimensions			额定负荷 Basic Load Rating		极限转速 Limiting Speed
	现型号 Current Code	原型号 Original Code		Fw	D	C	动 Dynamic	静 Static	油润滑 Oil
mm			g	mm			N		rpm
30	HMK3020			30	40	20			
	HK3024			30	37	24			
	HMK3025			30	40	25			
	HK3026		52.9	30	37	26	24000	50000	8100
	BK3026		59.4	30	37	26	24000	50000	8100
	HK3030			30	37	30			
	HMK3030			30	40	30			
	HK3038		76.1	30	37	38	32500	74000	8100
	BK3038		82.5	30	37	38	32500	74000	8100
	HK30X38X12	27941/30K	28	30	38	12	38100	80000	8100
	HK30X38X16	7941/30	32.7	30	38	16	39000	82000	8100
	HK30X38X24	7942/30	49	30	38	24	39910	88800	8100
HK30X38X32	7943/30	69	30	38	32	38890	88700	8100	
32	HK32X38X11		17	32	38	11	19700	43200	7800
	HMK3220			32	42	20			
	HK3224	77941/32	50.7	32	38	24	25500	52000	7300
	HK3232	97941/32	66.4	32	39	32	22600	54300	7100
	HK32X19X16			32	19	16			
	HK32X40X32	7943/32	72.7	32	39	32	27990	59890	7100
	HK32X41X16			32	41	16			
35	HK3512	27941/35	27.7	35	40	12	12100	19300	7100
	BK3512	25941/35	32.9	35	42	12	12100	19300	7100
	HK3516	47941/35	36.9	35	42	16	15700	27500	7100
	BK3516	45941/35	43.8	35	42	16	15700	27500	7100
	HK3520	67941/35	46.1	35	42	20	20800	41000	7100
	BK3520	65941/35	54.8	35	42	20	20800	41000	7100
	HK3520/ASI			35	42	20			
	HK3524			35	42	24			
	BK3530			35	42	30			
	HK3530			35	42	30			
	HMK3520			35	45	20			
	HMK3525			35	45	25			
	HMK3530			35	45	30			
	HK35X42X16	7941/35	37	35	42	16	24200	47100	7100
	HK35X43X25	7942/35	60.5	35	43	25	24440	48200	6200
HK35X43X32	7943/35	80	35	43	32	24870	48880	6200	
HK35X45X12		31	35	45	12	24870	48880	6200	
36	HK36X42X12		23	36	42	12	15000	21000	6200
38	HK3818			38	45	18			

# 冲压外圈滚针轴承

## Drawn Cup Needle Roller Bearings

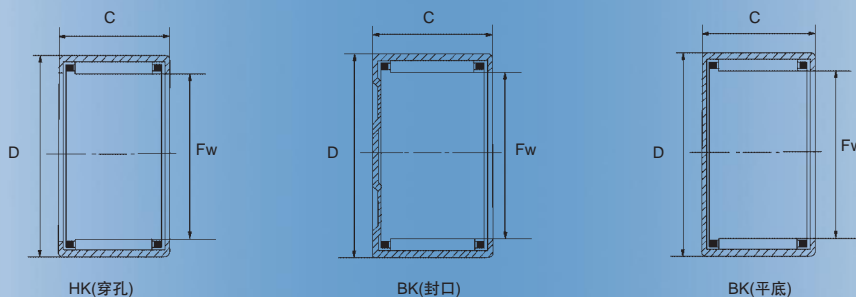

轴径 Shaft Diameter	轴承型号 Bearing Designation		重量 Mass 近似 Approx	外形尺寸 Boundary Dimensions			额定负荷 Basic Load Rating		极限转速 Limiting Speed
	现型号 Current Code	原型号 Original Code		Fw	D	C	动 Dynamic	静 Static	
mm			g	mm			N		rpm
38	HK38X48X30		102	38	48	30	16100	24100	6000
40	HK4012	27941/40	31.1	40	47	12	14000	24300	6300
	BK4012	25941/40	38.2	40	47	12	14000	24300	6300
	HK4016	47941/40	41.4	40	47	16	20000	38500	6300
	BK4016	45941/40	51	40	47	16	20000	38500	6300
	HK4020	67941/40	51.8	40	47	20	25500	52000	6300
	BK4020	65941/40	62	40	47	20	25500	52000	6300
	HK4020/ASI			40	47	20			
	HK4026			40	47	26			
	HK4030			40	47	30			
	HMK4020			40	50	20			
	HK4025	TA4025		40	50	25			
	HMK4030			40	50	30			
	HK40X50X32	7942/40	114.3	40	50	32	23000	42000	6000
HK40X50X38	7943/40	130.8	40	50	38	24100	43000	6000	
45	HK4512	27941/45	34.8	45	52	12	12900	22500	5800
	BK4512	25941/45	45	45	52	12	12900	22500	5800
	HK4512-K			45	52	12			
	HK4516	47941/45	46.2	45	52	16	19300	38000	5800
	BK4516	45941/45	56	45	52	16	19300	38000	5800
	HK4520	67941/45	56	45	52	20	22000	51000	5800
	BK4520	65941/45	72	45	52	20	22000	51000	5800
	HK4520-ASI			45	52	20			
	HK4520-K			45	52	20			
	HK4520-YA			45	52	20			
	HMK4525			45	55	25			
	HMK4530			45	55	30			
	HMK4538			45	55	38			
HK45X55X38	7943/45	135	45	55	38	27600	61000	5300	
50	HK50X57X16		51.2	50	57	16	15200	32500	5300
	HK5012	27941/50	44.2	50	58	12	23600	57200	5300
	HK5020	57941/50	72	50	58	20	28000	60000	5300
	BK5020	55941/50	87.3	50	58	20	28000	60000	5300
	HK5025	7943/50	90.1	50	58	25	34500	80000	5300
	BK5025	5943/50	109	50	58	25	34500	80000	5300
55	HK50X60X38		140	50	60	38	27770	63100	4600
	HK5520	57941/55	78	55	63	20	29500	59900	4600
	BK5520	55941/55	93.8	55	63	20	29500	59900	4600
	HK5525	77941/55	109	55	63	25	33200	69980	4600

# 冲压外圈滚针轴承

## Drawn Cup Needle Roller Bearings

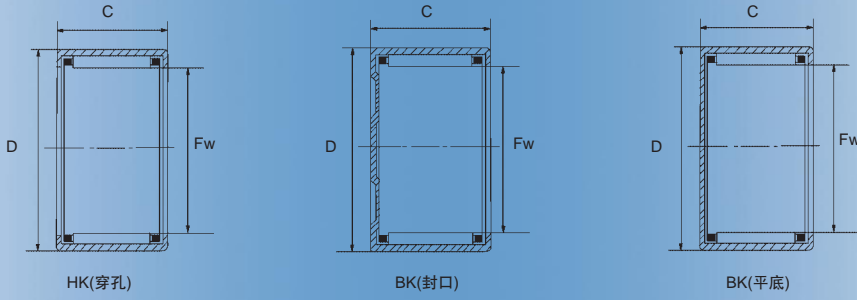

轴径 Shaft Diameter	轴承型号 Bearing Designation		重量 Mass 近似 Approx	外形尺寸 Boundary Dimensions			额定负荷 Basic Load Rating		极限转速 Limiting Speed
	现型号 Current Code	原型号 Original Code		Fw	D	C	动 Dynamic	静 Static	油润滑 Oil
mm			g	mm			N		rpm
55	HK5528	87941/55	111	55	63	28	39090	98000	4600
	BK5528	85941/55	132	55	63	28	39090	98000	4600
60	HK6012		49.2	60	68	12	12400	29000	4100
	BK6012		77	60	68	12	12400	29000	4100
	HK6020	57941/60	86	60	68	20	30500	72000	4100
	BK6020	55941/60	105	60	68	20	30500	72000	4100
	HK6032	87941/60	136	60	68	32	50000	131000	4100
	BK6032	85941/60	164	60	68	32	50000	131000	4100



# 冲压外圈滚针轴承

## Drawn Cup Needle Roller Bearings

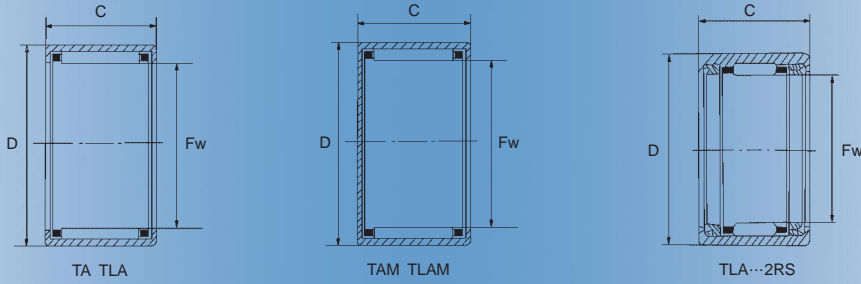

轴径 Shaft Diameter	轴承型号 Bearing Designation		重量 Mass 近似 Approx	外形尺寸 Boundary Dimensions			额定负荷 Basic Load Rating		极限转速 Limiting Speed
	现型号 Current Code	原型号 Original Code		Fw	D	C	动 Dynamic	静 Static	
mm			g	mm			N		rpm
4	TLA 48		1.6	4	8	8	140	100	75000
5	TLA 59		1.8	5	9	9	190	160	65000
6	TLA 69			6	10	9	210	190	55000
7	TLA 79		2	7	11	9	250	250	50000
8	TLA 810		2.1	8	12	10	340	370	45000
	TA 810			8	15	10	350	290	45000
	TA 815			8	15	15	590	570	45000
9	TA 912		1.8	9	16	12	520	500	45000
	TA 916		2.1	9	16	16	710	740	45000
10	TLA 1010		2.2	10	14	10			
	TLAM 1010		2.2	10	14	10			
	TLA 1012		2.6	10	14	12			
	TLAM 1012		2.3	10	14	12			
	TLA 1014 2RS		2.5	10	14	14			
	TLA 1015			10	14	15			
	TA 101610		2.3	10	16	10			
	TA 1012		2.9	10	17	12			
	TA 1010			10	17	10	420	390	40000
TA 1012		2.2	10	17	12	570	570	40000	
12	TLA 1212		2.4	12	18	12			
	TA 1212		2.7	12	19	12	610	640	35000
	TA 1215			12	19	15	760	850	35000
	TLA 1216 2RS		3	12	18	16			
13	TLA 1312		3	13	19	12	690	830	30000
14	TLA 1412		3.4	14	20	12			
	TLA 1416			14	20	16			
	TLA 1416 2RS		5.35	14	20	16			
	TA 1420		5.8	14	22	20	1410	1760	30000
15	TLA 1512		6.6	15	21	12			
	TLAM 1516		3	15	21	16			
	TA 1510		3.4	15	22	10	540	580	25000
	TA 1512		4	15	22	12	730	850	25000
16	TLA 1612		4.3	16	22	12			
	TLA 1616		4.1	16	22	16			
	TA1616		4.6	16	24	16	1130	1350	25000
	TA1620		4.9	16	24	20	1490	1940	25000
17	TLA172220		5.6	17	22	20			
	TLA172318			17	23	18			
	TA1715			17	24	15	980	1300	25000

# 冲压外圈滚针轴承

## Drawn Cup Needle Roller Bearings

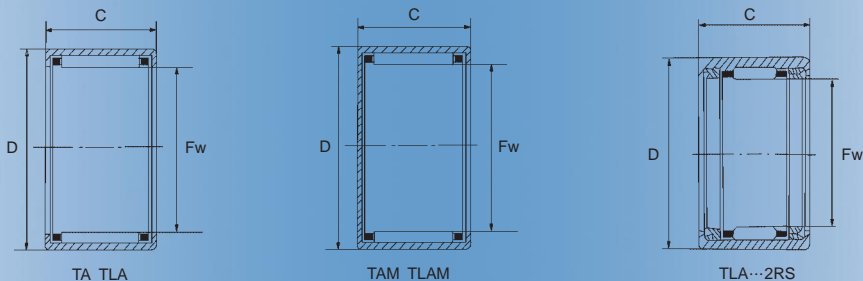

轴径 Shaft Diameter	轴承型号 Bearing Designation		重量 Mass 近似 Approx	外形尺寸 Boundary Dimensions			额定负荷 Basic Load Rating		极限转速 Limiting Speed
	现型号 Current Code	原型号 Original Code		Fw	D	C	动 Dynamic	静 Static	油润滑 Oil
mm			g	mm			N		rpm
18	TLA 1812			18	24	12			
	TLA 1816			18	24	16			
	TA 1813		16.4	18	25	13	930	1220	20000
	TA 1815		18.5	18	25	15	1020	1390	20000
	TA 1817		21	18	25	17	1210	1720	20000
19	TA 1916		23	19	27	16	1240	1600	20000
	TA 1920		29	19	27	20	1650	2300	20000
20	TLA 2012			20	26	12			
	TLA 2016			20	26	16			
	TLAM 2020			20	26	20			
	TA 2015		20	20	27	15	1060	1490	20000
21	TA 2116		25	21	29	16	1350	1840	19000
	TA 2120		31.5	21	29	20	1790	2640	19000
22	TA 2210		15	22	29	10	680	870	18000
	TA 2215		21.5	22	29	15	1130	1670	18000
24	TA 2420		31	24	31	20	1730	2980	16000
25	TLA 2530			25	32	30			
	TA 2510		19.1	25	33	10	810	1010	15000
	TA 2515		28.5	25	33	15	1370	1970	15000
26	TA 2616		30.5	26	34	16	1550	2330	15000
	TA 2620		38	26	34	20	2050	3350	15000
28	TLA 2820			28	35	20			
	TA 2820		45	28	37	20	2160	3290	13000
	TA 2830		67.5	28	37	30	3370	5800	13000
29	TA 2920		47	29	38	20	2250	3480	13000
	TA 2930		70	29	38	30	3490	6140	13000
30	TLA 3012		23.5	30	37	12	1060	1700	12000
	TA 3013		36.5	30	40	13	1370	1710	12000
	TA 3015		42	30	40	15	1720	2280	12000
	TLA 3026		49	30	37	26	2530	5190	12000
	TLA 303730			30	37	30			
	TLA 3038			30	37	38			
	TLAM 303746			30	37	46			
	TLA 303815			30	38	15			
	TLA 303816			30	38	16			
32	TLA 3030			30	40	30			
	TA 3220		57.5	32	42	30	2590	3940	11000
	TA 3230		86	32	42	30	4030	6970	11000
35	TLA 3516			35	42	16			

# 冲压外圈滚针轴承

## Drawn Cup Needle Roller Bearings

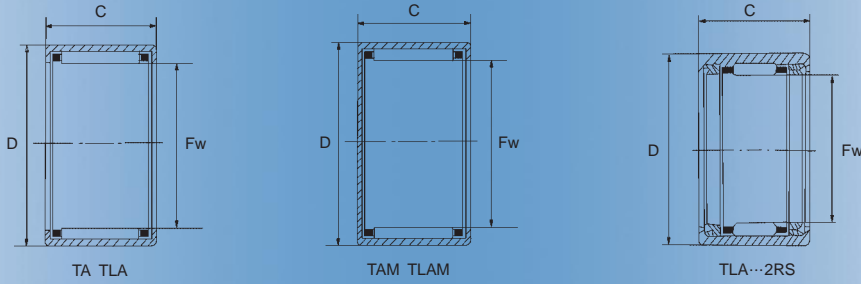

轴径 Shaft Diameter	轴承型号 Bearing Designation		重量 Mass 近似 Approx	外形尺寸 Boundary Dimensions			额定负荷 Basic Load Rating		极限转速 Limiting Speed
	现型号 Current Code	原型号 Original Code		Fw	D	C	动 Dynamic	静 Static	油润滑 Oil
mm			g	mm			N		rpm
35	TLA 3520			35	42	20			
	TLA 354320			35	43	20			
	TA 3512		38.5	35	45	12	1510	2030	10000
	TA 3515		48	35	45	15	1890	2710	10000
	TA 3520		62.5	35	45	20	2760	4400	10000
	TA 3530			35	45	30			
37	TA 3720		64.5	37	47	20	2830	4630	9500
	TA 3730		101	37	47	30	4270	7820	9500
38	TA 3815		51	38	48	15	1930	2860	9000
	TA 3820		65.5	38	48	20	2820	4640	9000
	TA 3825		82.5	38	48	25	3630	6430	9000
40	TLA 4012			40	47	12			
	TLA 4016			40	47	16			
	TA 4015		54	40	50	15	1980	3000	8500
	TA 4020		69.5	40	50	20	2900	4880	8500
45	TA 4520		77	45	55	20	3120	5570	7500
	TA 4525		102	45	55	25	4010	7710	7500
	TA 4530		122	45	55	30	4860	9850	7500
50	TLA 5020		69	50	58	20	2930	6540	6500
	TLA 5025		86	50	58	25	3760	9010	6500
	TA 5012		62.5	50	62	12	1800	2450	6500
	TA 5015		78	50	62	15	2630	3980	6500
	TA 5020		107	50	62	20	3870	6530	6500
	TA 5025		134	50	62	25	5000	9080	6500
	TAW 5045		230	50	62	45	7820	16100	6500
55	TA 5520		116	55	67	20	4040	7100	5500
	TA 5525		145	55	67	25	5220	9880	5500
	TA 5530		175	55	67	30	6320	12600	5500
	TAW 5550		280	55	67	50	9330	20900	5500
60	TA 6025		158	60	72	25	5570	11100	5000
	TA 6030		191	60	72	30	6760	14200	5000
	TA 6040		250	60	72	40	8740	19700	5000
62	TA 6212		78	62	74	12	2050	3090	4500
65	TA 6525		169	65	77	25	5760	11900	4000
	TA 6530		205	65	77	30	6980	15200	4000
70	TA 7025		181	70	82	25	5960	12700	3500
	TA 7030		220	70	82	30	7230	16200	3500
	TA 7040		290	70	82	40	9380	22700	3500

# 冲压外圈滚针轴承 (英制系列)

Drawn Cup Needle Roller Bearings (Inch series)

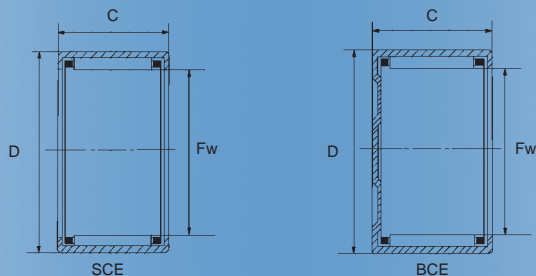

轴径 Shaft Diameter	轴承型号 Bearing Designation		重量 Mass 近似 Approx	外形尺寸 Boundary Dimensions			额定负荷 Basic Load Rating		极限转速 Limiting Speed
	现型号 Current Code	原型号 Original Code		Fw	D	C	动 Dynamic	静 Static	油 润滑 Oil
mm			kg	mm			N		rpm
3.175	SCE 55 + 内套		0.004	3.175	12.7	8.334			
3.97	SCE 21/24TN			3.97	7.15	6.35			
4.762	SCE 34TN			4.762	8.731	6.35			
6.35	SCE 47		0.004	6.35	11.112	11.13			
	SCE 49			6.35	11.112	14.287			
	SCE 49PP			6.35	11.112	14.29			
7.938	SCE 55	BCE55	0.0032	7.938	12.7	7.938	2892	2625	29000
	SCE 56P		0.006	7.938	12.7	9.52			
	SCE 57		0.006	7.938	12.7	11.11			
	SCE 59		0.003	7.938	12.7	14.29			
9.525	SCE 65	BCE65	0.004	9.525	14.288	7.94	2892	2417	25000
	SCE 66		0.006	9.525	14.288	9.52	3900	3950	29500
	SCE 68		0.0065	9.525	14.288	12.7			
	SCE 68K			9.525	14.288	9.271			
	SCE 69P		0.007	9.525	14.288	14.29			
	SCE 69		0.004	9.525	14.288	14.29			
	SCE 610PP			9.525	14.288	15.88	3900	3950	29500
11.112	SCE 78		0.005	11.112	15.875	12.7	6400	7800	25000
12.7	SCE 85		0.0047	12.7	17.462	7.94			
	SCE 86		0.006	12.7	17.462	9.52			
	SCE 86A		0.007	12.7	17.462	9.52			
	SCE 87		0.006	12.7	17.462	11.11	7340	7800	22000
	SCE 88		0.009	12.7	17.462	12.7	6897	9033	19000
	SCE 810ZOH		0.009	12.7	17.462	15.88	8811	12237	19000
	SCE 810PP		0.009	12.7	17.462	15.88	8811	12237	19000
14.288	SCE 96		0.005	14.288	19.05	9.52	5162	6408	18000
	SCE 98		0.008	14.288	19.05	12.7	7698	10769	18000
	SCE 910		0.01	14.288	19.05	15.88	9434	14017	18000
	SCE 912		0.013	14.288	19.05	19.05	10724	16465	18000
15.875	SCE 105		0.0075	15.875	20.638	7.94	4300	5200	17600
	SCE 107-1/2		0.009	15.875	20.638	11.91	7100	10300	17600
	SCE108	BCE108	0.01	15.875	20.638	12.7	8743	12015	16000
	SCE109P			15.875	20.638	14.29	8743	12015	16000
	SCE1010		0.011	15.875	20.638	15.88	10368	16242	16000
	SCE1010PP		0.013	18.875	20.638	15.88	10368	16242	16000
	SCE1012		0.014	15.875	20.638	19.05	12015	19802	16000
17.462	SCE1012PP		0.014	15.875	20.638	19.05	12015	19802	16000
	SCE118		0.014	17.462	22.225	12.7	8600	13200	16000
	SCE1112		0.016	17.462	22.225	19.05	12400	21000	16000

# 冲压外圈滚针轴承 (英制系列)

## Drawn Cup Needle Roller Bearings (Inch series)

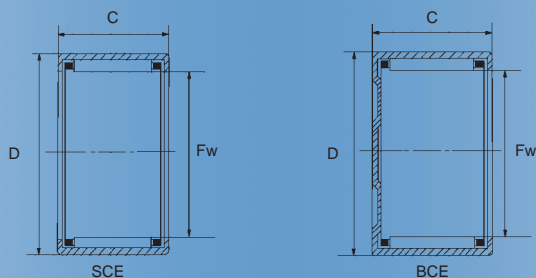

轴径 Shaft Diameter	轴承型号 Bearing Designation		重量 Mass 近似 Approx	外形尺寸 Boundary Dimensions			额定负荷 Basic Load Rating		极限转速 Limiting Speed
	现型号 Current Code	原型号 Original Code		Fw	D	C	动 Dynamic	静 Static	油润滑 Oil
mm			kg	mm			N		rpm
19.05	SCE 128		0.013	19.05	25.4	12.7	9800	12500	14700
	SCE 120			19.05	34	14.5			
	SCE 129P		0.019	19.05	25.4	14.29	10000	13500	15200
	SCE 1210PPR		0.017	19.05	25.45	15.88	12682	17577	13000
	SCE 1211(P)		0.018	19.05	25.4	17.46	15352	22250	13000
	SCE 1212		0.021	19.05	25.4	19.05	15352	22250	13000
	SCE 1214PP			19.05	25.4	22.22			
SCE 1216		0.030	19.05	25.4	25.4				
20.638	SCE 1312		0.024	20.638	26.988	19.05	16020	23585	12000
22.225	SCE 146		0.013	22.225	28.575	9.52	8200	10700	12600
	SCE 148		0.019	22.225	28.575	12.7	11125	15797	11000
	SCE 148-OH		0.019	22.225	28.575	12.7	11125	15797	11000
	SCE 1412		0.028	22.225	28.575	19.05	16910	27145	11000
	SCE 1416		0.034	22.225	28.575	25.4	22100	38000	12600
25.4	SCE 168		0.019	25.4	31.75	12.7	12682	19135	10000
	SCE 1612		0.027	25.4	31.75	19.05	18022	30260	10000
	SCE 1614PP			25.4	31.75	22.22			
	SCE 1616		0.038	25.4	31.75	25.4	24920	45390	10000
	SCE 1616PP		0.038	25.4	31.75	25.4	24920	45390	10000
	SCE 1620		0.048	25.4	31.75	31.75			
28.575	SCE 188		0.021	28.575	34.925	12.7	12905	20247	9000
	SCE 1816	BCE1816	0.04	28.575	34.925	25.4	25810	49395	9000
	SCE 1820		0.053	28.575	34.925	31.75			
31.242	SCE 2020A			31.242	38.1	31.75			
31.75	SCE 2010		0.03	31.75	38.1	15.88	21137	39605	8000
	SCE 2012		0.037	31.75	38.1	19.05	16500	29000	8000
	SCE 2016	BCE2016	0.045	31.75	38.1	25.4	27145	54735	8800
	SCE 2020		0.056	31.75	38.1	31.75			
34.925	SCE 228		0.025	34.925	41.275	12.7	13600	23700	8000
	SCE 2212		0.039	34.925	41.275	19.05	21360	42720	7500
	SCE 2216		0.058	34.925	41.275	25.4	27590	59185	7500
	SCE 2220		0.081	34.925	41.275	31.75	34000	77000	8000
38.1	SCE 2416		0.083	38.1	47.625	25.4	38715	66305	6500
	SCE 2420		0.105	38.1	47.625	31.75			
41.275	SCE 2620		0.11	41.275	50.8	31.75	51000	97000	6800
44.45	SCE 2812		0.082	44.45	53.975	19.05	31500	55000	6300
	SCE 2816	BCE2816	0.115	44.45	53.975	25.4	41385	75650	6000
	SCE 2824		0.163	44.45	53.975	38.1			
50.8	SCE 3216		0.102	50.8	60.33	25.4			

# 冲压外圈滚针轴承 (英制系列)

Drawn Cup Needle Roller Bearings (Inch series)

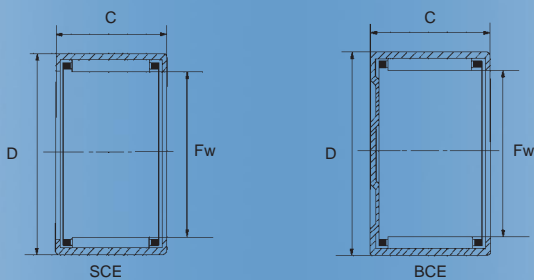

轴径 Shaft Diameter	轴承型号 Bearing Designation		重量 Mass 近似 Approx	外形尺寸 Boundary Dimensions			额定负荷 Basic Load Rating		极限转速 Limiting Speed
	现型号 Current Code	原型号 Original Code		Fw	D	C	动 Dynamic	静 Static	油润滑 Oil
mm			kg	mm			N		rpm
50.8	SCE 32 160OH			50.8	60.38	25.4			
	SCE 3220		0.140	50.8	60.325	31.75	55180	115700	5000

注: OH、ZOH 带油孔; P PP 带密封圈。

Note: OH、ZOH with oil hole; P PP with seal ring.

# 冲压外圈滚针轴承 (英制系列)

## Drawn Cup Needle Roller Bearings (Inch series)

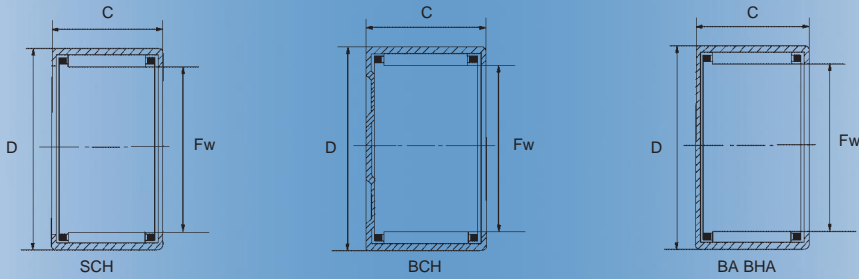

轴径 Shaft Diameter	轴承型号 Bearing Designation		重量 Mass 近似 Approx	外形尺寸 Boundary Dimensions			额定负荷 Basic Load Rating		极限转速 Limiting Speed
	现型号 Current Code	原型号 Original Code		Fw	D	C	动 Dynamic	静 Static	油润滑 Oil
mm			kg	mm			N		rpm
12.7	SCH 87		0.009	12.7	19.05	11.13			
14.29	SCH 910		0.013	14.29	20.64	15.88			
	SCH 912		0.017	14.29	20.64	19.05			
15.875	SCH 108		0.013	15.875	22.225	12.7			
	SCH 1012		0.019	15.875	22.225	19.05			
22.225	SCH 1412		0.032	22.225	30.162	19.05			
	SCH 1413			22.225	30.162	20.64			
	SCH 1413P			22.225	30.162	20.64			
	SCH 1416PP			22.225	30.162	25.4			
25.4	SCH 1416		0.043	22.225	30.162	25.4			
	SCH 1612		0.036	25.4	33.338	19.05			
	SCH 1614P			25.4	33.338	22.22			
28.575	SCH 1616		0.047	25.4	33.338	25.4			
	SCH 1812		0.048	28.575	38.1	19.05			
31.75	SCH 1816		0.063	28.575	38.1	15.4			
	SCH 2016		0.071	31.75	41.28	25.4			
34.925	SCH 2213P			34.925	44.45	20.62			
BCH 系列									
9.525	BCH 68		0.0082	9.525	15.875	12.7	500	480	40000
17.02	BCH 06604			17.02	23.83	17.53			
31.75	BCH 2020		0.0815	31.75	41.275	31.75	4080	7100	12000
BHA 系列									
12.7	BHA 88ZOH		0.0104	12.7	19.05	12.7	620	680	30000
	BHA 810ZOH		0.0125	12.7	19.05	15.88	900	1110	30000
17.462	BHA 1112ZOH		0.0193	17.462	23.812	19.05	1350	2020	25000
25.4	BHA 1612		0.0335	25.4	33.338	19.05	1970	3030	15000
28.575	BHA 1816ZOH		0.06	28.575	38.1	25.4	3050	4950	13000
31.75	BHA 2020ZOH		0.0815	31.75	41.275	31.75	4080	7100	12000

# 冲压外圈滚针轴承 (英制系列)

Drawn Cup Needle Roller Bearings (Inch series)

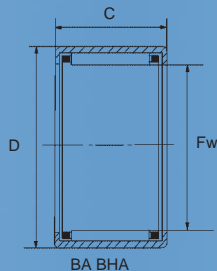

轴径 Shaft Diameter	轴承型号 Bearing Designation		重量 Mass 近似 Approx	外形尺寸 Boundary Dimensions			额定负荷 Basic Load Rating		极限转速 Limiting Speed
	现型号 Current Code	原型号 Original Code		Fw	D	C	动 Dynamic	静 Static	油润滑 Oil
mm			g	mm			N		rpm
6.35	BA 44ZOH		2.1	6.35	11.112	6.35	150	110	55000
	BA 47ZOH		3.5	6.35	11.112	11.13	270	240	55000
7.938	BA 55ZOH		3	7.938	12.7	7.92	190	160	45000
	BA 57ZOH		4.3	7.938	12.7	11.13	340	330	45000
9.525	BA 66		4.2	9.525	14.288	9.525	320	310	40000
	BA 66ZOH		4.2	9.525	14.288	9.52	320	310	40000
	BA 68		5.7	9.525	14.288	12.7	430	470	40000
	BA 610Z		7	9.525	14.288	15.88	580	680	40000
12.7	BA 88ZOH		7.2	12.7	17.462	12.7	480	580	30000
	BA 810		8.9	12.7	17.462	15.88	650	850	30000
	BA 810ZOH		8.9	12.7	17.462	15.88	650	850	30000
	BA 812ZOH		10.6	12.7	17.462	19.05	800	1120	30000
14.288	BA 910ZOH		9.9	14.288	19.05	15.88	720	1010	30000
15.875	BA 105Z		5.3	15.875	20.638	7.94	290	330	25000
	BA 107ZOH		7.6	15.875	20.638	11.11	510	680	25000
	BA 108ZOH		8.7	15.875	20.638	12.7	550	740	25000
	BA 1010ZOH		10.8	15.875	20.638	15.88	750	1100	25000
	BA 1012Z		12.9	15.875	20.638	19.05	920	1430	25000
17.462	BA 118ZX		9.5	17.462	22.225	12.7	630	900	25000
19.05	BA 126ZOH		10	19.05	25.4	9.52	510	600	20000
	BA 128		13.5	19.05	25.4	12.7	700	890	20000
	BA128ZOH		13.5	19.05	25.4	12.7	700	890	20000
	BA 1210		17	19.05	25.4	15.88	970	1350	20000
	BA 1210ZOH		17	19.05	25.4	15.88	970	1350	20000
	BA 1212ZOH		20.5	19.05	25.4	19.05	1220	1800	20000
22.225	BA 146ZOH		11.5	22.225	28.575	9.52	550	690	18000
	BA 148ZOH		15.6	22.225	28.575	12.7	760	1080	18000
	BA 1412ZOH		23.5	22.225	28.575	19.05	1310	2080	18000
	BA 1416ZOH		31	22.225	28.575	25.4	1790	3110	18000
25.4	BA 1612		26.5	25.4	31.75	19.05	1450	2470	15000
	BA 1612ZOH		26.5	25.4	31.75	19.05	1450	2470	15000
	BA 1616		35.5	25.4	31.75	25.4	1980	3700	15000
	BA 1616ZOH		35.5	25.4	31.75	25.4	1980	3700	15000
28.575	BA 188		19.5	28.575	34.925	12.7	880	1360	13000
	BA 1816Z		39	28.575	34.925	25.4	2090	4110	13000
	BA 1816		39	28.575	34.925	25.4	2090	4110	13000
30.162	BA 1916ZOH		52	30.162	38.1	25.4	2630	4620	12000
31.75	BA 2012		32.5	31.75	38.1	19.05	1600	3020	12000
	BA 2012ZOH		32.5	31.75	38.1	19.05	1600	3020	12000



# 冲压外圈滚针轴承 (英制系列)

## Drawn Cup Needle Roller Bearings (Inch series)

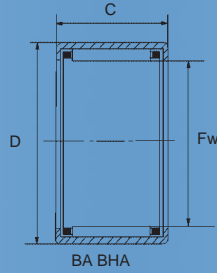

轴径 Shaft Diameter	轴承型号 Bearing Designation		重量 Mass 近似 Approx	外形尺寸 Boundary Dimensions			额定负荷 Basic Load Rating		极限转速 Limiting Speed
	现型号 Current Code	原型号 Original Code		Fw	D	C	动 Dynamic	静 Static	油润滑 Oil
mm			g	mm			N		rpm
31.75	BA 2016ZOH		43	31.75	38.1	25.4	2190	4520	12000
	BA 2020		53.5	31.75	38.1	31.75	2750	6040	12000
	BA 2020ZOH		53.5	31.75	38.1	31.75	2750	6040	12000
34.525	BA 2216ZOH		47.5	34.925	41.275	25.4	2350	5120	10000
38.1	BA 2420		97.5	38.1	47.625	31.75	3980	7570	9000
	BA 2420ZOH		97.5	38.1	47.625	31.75	3980	7570	9000
41.275	BA 2610		52	41.275	50.8	15.88	1930	3060	8000
	BA 2620ZOH		105	41.275	50.8	31.75	4220	8370	8000
44.45	BA 2812ZOH		67.5	44.45	53.975	19.05	2570	4540	7500
	BA 2816ZOH		91	44.45	53.975	25.4	3540	6870	7500
50.8	BA 3216ZOH		104	50.8	60.325	25.4	3780	7800	6000
BAM 系列									
9.525	BAM 66K			9.525	14.288	10.5			
	BAM 66		4.6	9.525	14.2875	9.525	320	310	40000
12.7	BAM 812		11.3	12.7	17.462	19.05	800	1120	30000

# 冲压外圈滚针轴承 (英制系列)

Drawn Cup Needle Roller Bearings (Inch series)

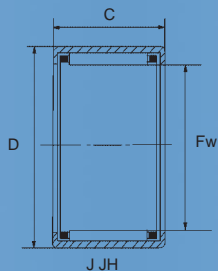

轴径 Shaft Diameter	轴承型号 Bearing Designation		重量 Mass 近似 Approx	外形尺寸 Boundary Dimensions			额定负荷 Basic Load Rating		极限转速 Limiting Speed	
	现型号 Current Code	原型号 Original Code		Fw	D	C	动 Dynamic	静 Static	脂润滑 Oil	油润滑 Oil
mm			g	mm			N			rpm
4.76	J-35			4.76	8.73	9.525	257	352		75000
6.35	J-45			6.35	11.11	7.92	290	331		57000
	J-47			6.35	11.11	11.13	473	617		57000
7.94	J-55			7.94	12.7	7.92	315	383		44000
	J-57			7.94	12.7	11.13	560	805		44000
	JH-57			7.94	14.29	11.13	696	849		47000
9.525	J-65			9.525	14.29	7.92	358	474		36000
	J-66			9.525	14.29	9.52	500	728		36000
	J-68			9.525	14.29	12.7	755	1240		36000
	JH-68			9.525	15.88	12.7	987	1370		38000
11.11	J-78			11.11	15.88	12.7	882	1580		30000
	JH-78			11.11	17.46	12.7	1060	1510		30000
12.548	J-88K			12.548	17.463	12.7	914	1710		26000
14.288	J-910			14.288	19.05	15.88	1190	2490		23000
	J-108			15.88	20.64	12.7	970	1970		21000
15.88	JH-1010			15.88	22.225	15.88	1280	2930		21000
17.462	JH-1112			17.462	23.812	19.05	1830	4610		19000
19.05	J-1212			19.05	25.4	19.05	2320	4880		18000
22.225	J-148			22.225	28.58	12.7	1640	3270		15000
	JH-1412			22.225	30.16	19.05	2710	5450		15000
	JH-14160H			22.225	30.162	25.4	2710	5450		15000
25.4	JH-1616			25.4	33.34	25.4	4090	9570		13000
28.58	JH-1818			28.58	38.1	28.58	5440	12500		12000
35.61	JH-1470			35.61	57.2	17.8	5680	13500		10000
41.275	J-2616			41.275	50.8	25.4	5890	15600		7900
50.8	J-3216			50.8	60.32	25.4	6350	18400		6300